

# CONTENTS

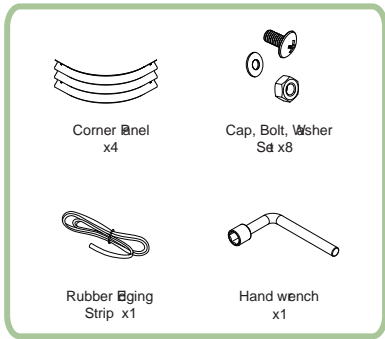

8" Oval Set

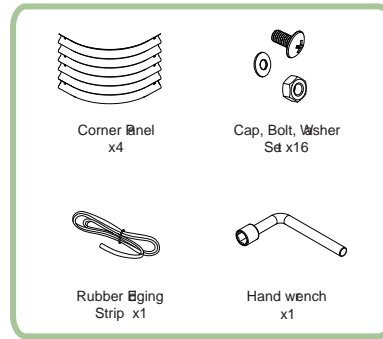

17" Oval Set

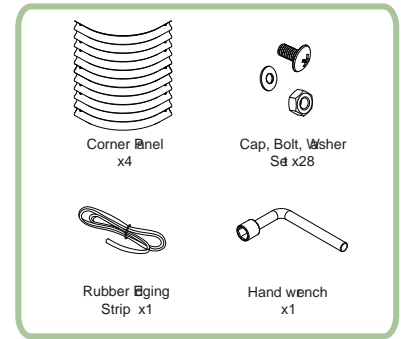

32" Oval Set

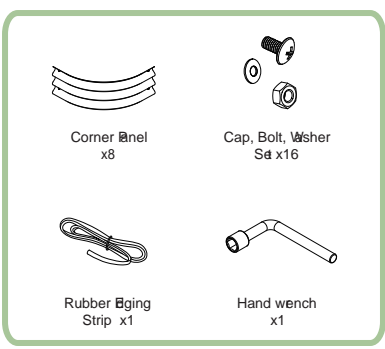

8" Oval Set of 2

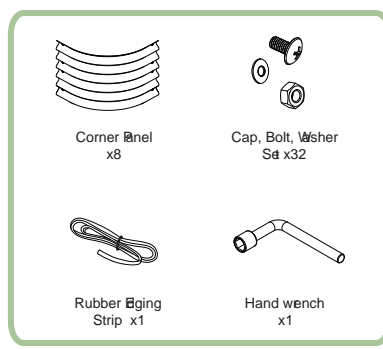

17" Oval Set of 2

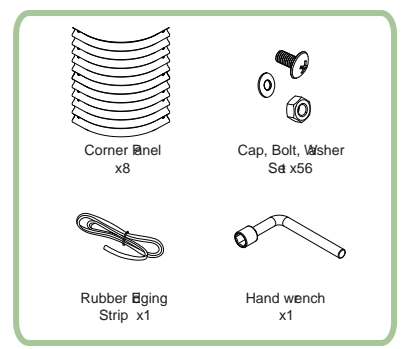

32" Oval Set of 2

# CONFIGURATION

8" Oval Set  
2ft X 2ft  
4 pieces



17" Oval Set  
2ft X 2ft  
4 pieces



32" Oval Set  
2ft X 2ft  
4 pieces



8" Oval Set of 2  
2ft X 2ft  
4 pieces



2ft X 2ft  
4 pieces



17" Oval Set of 2  
2ft X 2ft  
4 pieces



2ft X 2ft  
4 pieces



32" Oval Set of 2  
2ft X 2ft  
4 pieces



2ft X 2ft  
4 pieces



Configuration	Cubic Yrds
8"	0.08
17"	0.16
32"	0.32

# ASSEMBLY GUIDE

Caution: Metal panels have sharp edges and may cause injury. Using protective gear (gloves, closed toed shoes, etc.) is recommended.

1. Lay in desired configuration on a flat surface (Be mindful that paint may scratch if laid on rough surfaces).

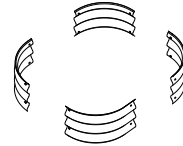

2. Loosely, assemble all straight panels with the bolt, washer and nut. Use the hand wrench to tighten.

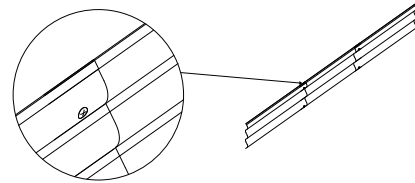

3. Attach corner panels on the outside of the straight panels and tighten all nuts.

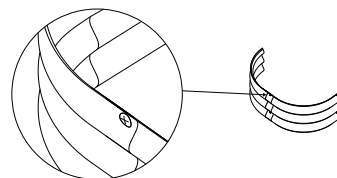

4. Push on rubber edging to the top edge of the box and cut off remainder.

